



SOCIETE  
LA MENUISERIE MODERNE

**SMM**



# **SOCIÉTÉ LA MENUISERIE MODERNE**



LA MENUISERIE MODERNE (SMM) est une entreprise spécialisée dans la fabrication d'ouvrages en aluminium et met aux services de sa clientèle tout son savoir faire. Pour les satisfaire , elle utilise comme matière première un matériau d'une très grande qualité et d'une longue durée de vie.

Dirigeant : Mr Mourad MASMOUDI & Mr Aziz GABROUNE

# PRODUITS

Menuiserie Coulissante &  
Battante



**SÉRIE 67 ELLIPSE**  
Menuiserie Coulissante



**SÉRIE EX60 PRESTIGE**  
Menuiserie Coulissante

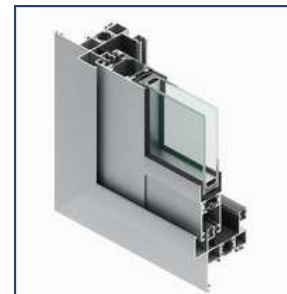

**SÉRIE TS60 CONFORT**  
Menuiserie Coulissante



**SÉRIE 40 ELLIPSE**  
Menuiserie Battante



**SÉRIE EX45 PRESTIGE**  
Menuiserie Battante



**SÉRIE TW60 CONFORT**  
Menuiserie Battante

# PRODUITS

## Menuiserie Coulissante & Battante



**CP 45 PA**  
Menuiserie Coulissante



**CP 130 LS**  
Menuiserie Coulissante



**CP 68**  
Menuiserie Coulissante



**TS 68**  
Menuiserie Battante



**CS 45 PA**  
Menuiserie Battante



**CS 77**  
Menuiserie Battante

# PRODUITS



Menuiserie Coulissante &  
Battante



**COR 80**  
Ouvrant caché



**COR 60**  
Ouvrant caché



**COR 3500**  
battant à RPT



**COR VISION PLUS**



**4900 COULISSANT HI**



**Porte fenêtre**  
Méditerranéenne  
coulissante



CORTIZO

# PRODUITS



## Garde corps vitré



### **Garde-Corps**

View Crystal



### **Garde-Corps**

View Crystal



### **Garde-corps**

View Crystal



### **Garde-Corps**

Juliet balcony



CORTIZO

# PRODUITS

Garde - corps

VIEW CRYSTAL

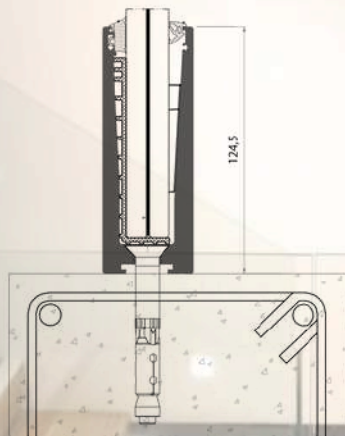

VIEW CRYSTAL  
VIEW CRYSTAL PLUS

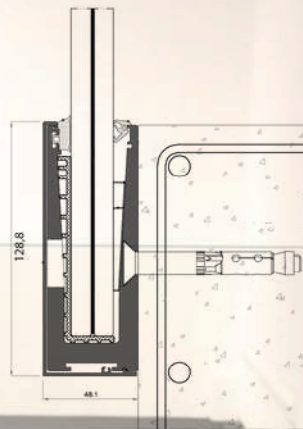

VIEW CRYSTAL PLUS

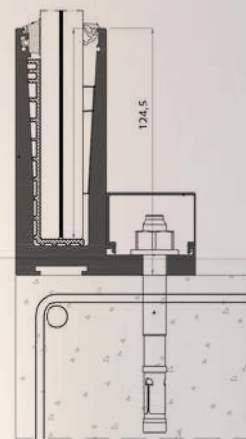

VIEW CRYSTAL  
VIEW CRYSTAL PLUS

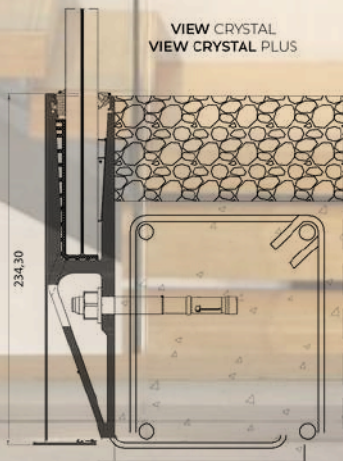

VIEW CRYSTAL  
VIEW CRYSTAL PLUS

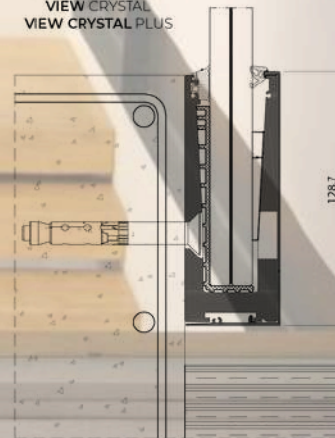

CORTIZO

# PRODUITS



Mur rideau

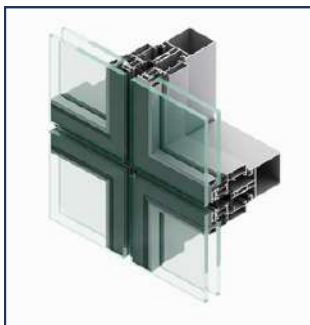

**SÉRIE 52 HORIZON+  
VEC TPR**

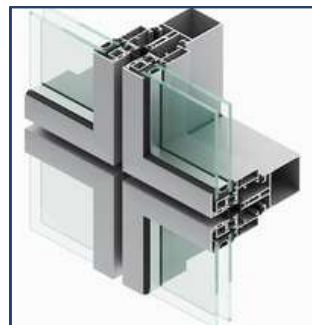

**SÉRIE 52 HORIZON+  
RPT VEP TPR**

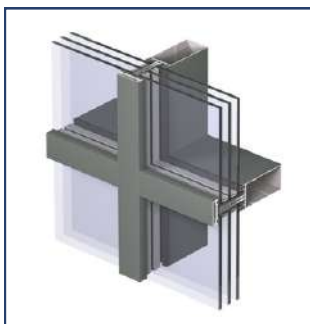

**CW 50 REYNAERS**



**Façade equity  
CORTIZO**

# PRODUITS

Les cloisons



# PRODUITS

## Les cloisons

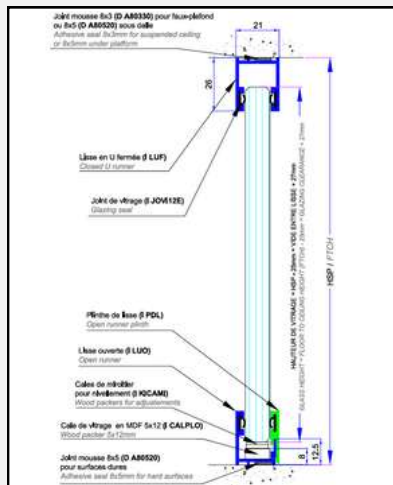

ID 1

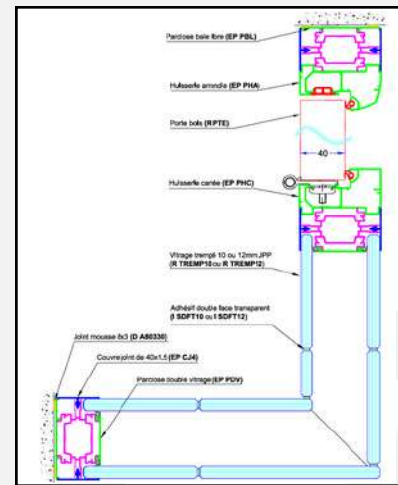

ID 2

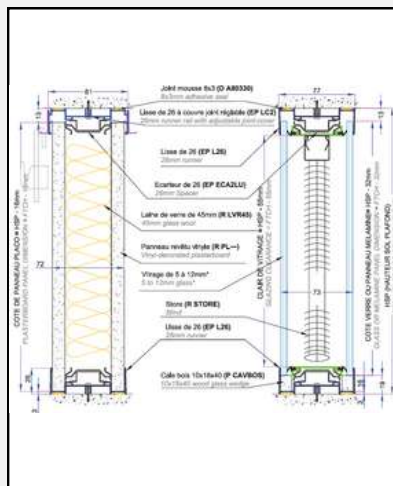

P 26

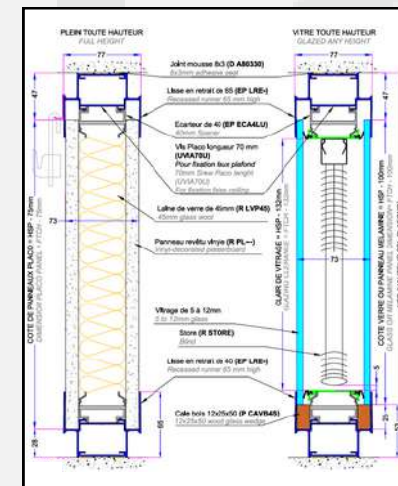

P 40

# PRODUITS

## Pergola bioclimatique

# P-190 et P-150

Système étanche

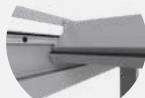

Étanchéité  
périmétrique brevetée



Récupération des  
eaux de pluie



Actionnement par  
moteur

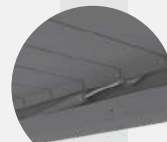

- La pergola bioclimatique est un système de protection solaire avec un design contemporain.
- Le système est basé sur un plafond à lames orientables fabriquées en aluminium extrudé.
- Les lames tournent de 0° à 135° grâce aux axes pivotants insérés dans les joues, qui permettent l'actionnement des lames par un moteur mécanique de 24 Vcc.
- Elles sont actionnées au moyen d'une platine en aluminium extrudé.
- Ce toit mobile est monté sur une structure en aluminium extrudé qui permet des possibilités de modulation infinies, offrant une résistance optimale à la pluie et aux charges dues à la neige.

## PRODUITS

### Lames sur profil guidé Aluminium

Lame R-100 LED  
Lame R-130 LED

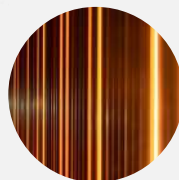

lames sur profil  
guidé LED

- Avec les lames A-150, R-130 LED et R-180, au moyen du profil R, nous obtenons une installation de la lame en position horizontale ou verticale qui s'adapte au design de la façade et crée une continuité de la lame.
- Avec les lames A-120, R-100 LED et R-150, grâce au profil base à facettes, nous obtenons une inclinaison sélectionnable de 90°, 45° et 30°.

#### R - 130 LED



Lame R-130 LED

Lame en ligne droite avec emplacement pour l'éclairage LED et une ouverture à une extrémité pour le clippage sur le profil base R qui forme la géométrie de l'ensemble R-130 LED.

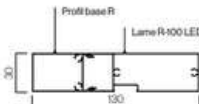

#### R - 100 LED



Lame R-100 LED

Lame à la ligne droite avec un emplacement pour l'éclairage LED et une ouverture à une extrémité pour le clippage sur le profil base à facettes qui forme la géométrie de l'ensemble LED R-100.

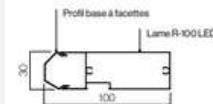

# REVETEMENT DE FACADE

## Panneaux composites STACBOND

Innovation dans chaque couche

Les panneaux composites STACBOND sont des produits innovants composés de deux feuilles d'aluminium de 0,5 mm d'épaisseur et d'une âme intérieure de charge minérale, disponibles en version non-combustible STACBOND A2 ou ignifuge STACBOND FR, et recouverts de peintures spéciales résistantes aux intempéries.



### Panneaux composites non-combustibles

#### STACBOND A2

Panneaux constitués de deux feuilles d'aluminium et d'une âme minérale non-combustible conçue pour satisfaire aux exigences réglementaires les plus rigoureuses en matière de classement de réaction au feu

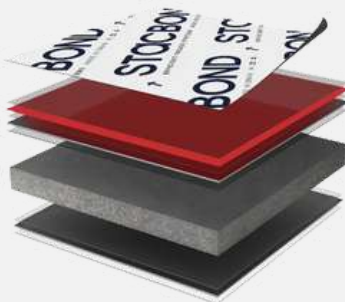

### Panneaux composites ignifuges

#### STACBOND FR

Panneaux composites constitués de deux feuilles d'aluminium et d'une âme intérieure de charge minérale ignifuge.



SOCIÉTÉ  
LA MENUISERIE MODERNE

# Nos références





**-HOTEL NINE**  
Route de la marsa

2024



**-HOTEL PALM BEACH**  
Hammamet

2024



**-ARENA GYM PREMIUM**

La soukra

2021

IDENTITY  
+ PARTNERS

MELLOULA DUTY  
FREE PRE-OPENING CER



**-DUTY FREE**  
Melloula

2019



**-CENTRE MEDICAL**  
Les jardins de carthage

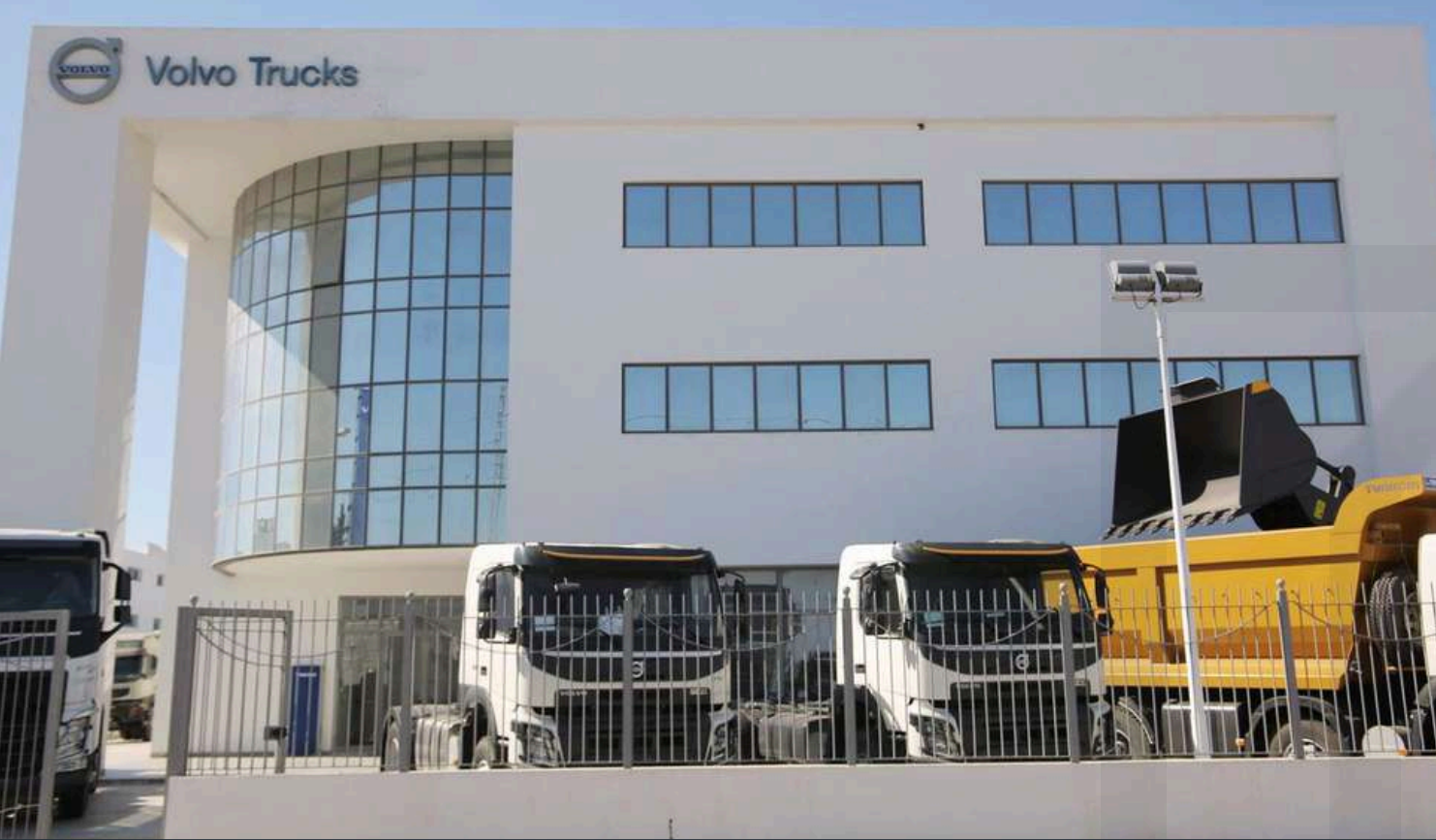

**-SIEGE DE SOCIETE VOLVO TRUCKS**  
Mghira

2020



**-SIEGE DE SOCIETE COPRA**  
Mghira



**-SIEGE TALYS CONSULTING**

Cité jardin Tunis



**-RESIDENCE ONYX**  
La soukra, chotrana



**-DIAR CARTHAGE**  
Les jardins de carthage



**-GOLDEN RESIDENCE**  
Les jardins de carthage

2018



**-RESIDENCE THE 28**  
Les jardins de carthage

2022



**-RESIDENCE CHERIFA**  
Les jardins de carthage

2021



**-SIEGE SOCIAL GFH**  
Tunis bay

2022



**-CITE DE LA CULTURE**  
Tunis, Avenue Mohamed V

2016-2017



**-THE PARANGON**  
Lac 2

2023



**-MIRMAR BUSINESS CITY**  
Centre urbain nord

2019



**-LADOUS DU LAC**  
Les berges du lac

2020



**-PERGOLA BIOCLIMATIQUE**  
Gammarth



**-MAISON DEDINE**  
Sidi bou said

2021



## VILLAS CONTEMPORAINES ACHEVEES





## VILLAS CONTEMPORAINES ACHEVEES





## LES CLOISONS

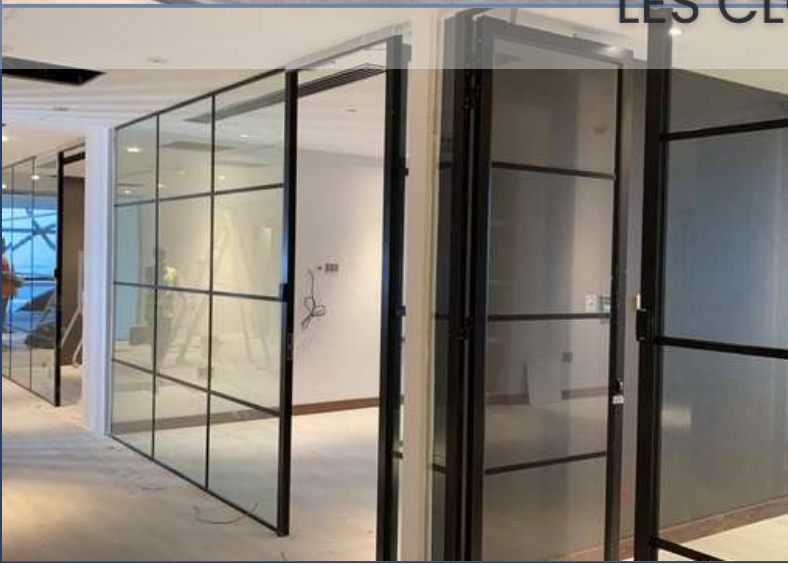



# SOCIÉTÉ LA MENUISERIE MODERNE

Une équipe de spécialistes de la conception et de la fabrication de menuiseries aluminium prêtes-à-poser exclusivement.

## **Notre Mission**

Etre impliqués dans la recherche des meilleures solutions possibles, en veillant à assurer la qualité, la précision et la performance de nos réalisations.

## **Notre vision**

Devenir un acteur de référence dans la menuiserie aluminium en alliant innovation et durabilité pour offrir à nos clients des solutions modernes et esthétiques, respectueuses de l'environnement.

## **Notre objectif**

Mettre au service de notre clientèle tout notre savoir faire dans la conception et la réalisation d'ouvrages en aluminium et l'enveloppe des bâtiments.



 **SMM**

SOCIÉTÉ MENUISERIE MODERNE